

# Installation Instructions: \_\_\_\_\_

**Type of Operation: Motor**

**Type of Mount: Inside**

All directions are provided assuming the installer is looking at the door from the coil side of the opening. (see drawing below) Some of the pictures are taken in the plant using our adjustable opening where we install and test every door before it is sent to you.

Proper installation of our doors can only be done if you are in a good mood. To that end, we have put a couple See's Suckers in the goody bag for your enjoyment.

If you have questions about the installation, feel free to call us at 503.357.7181 from 7am until 5pm Monday through Thursday, Fridays 7am until 3pm (Pacific time).

Now let's get started.

## View From Coil Side

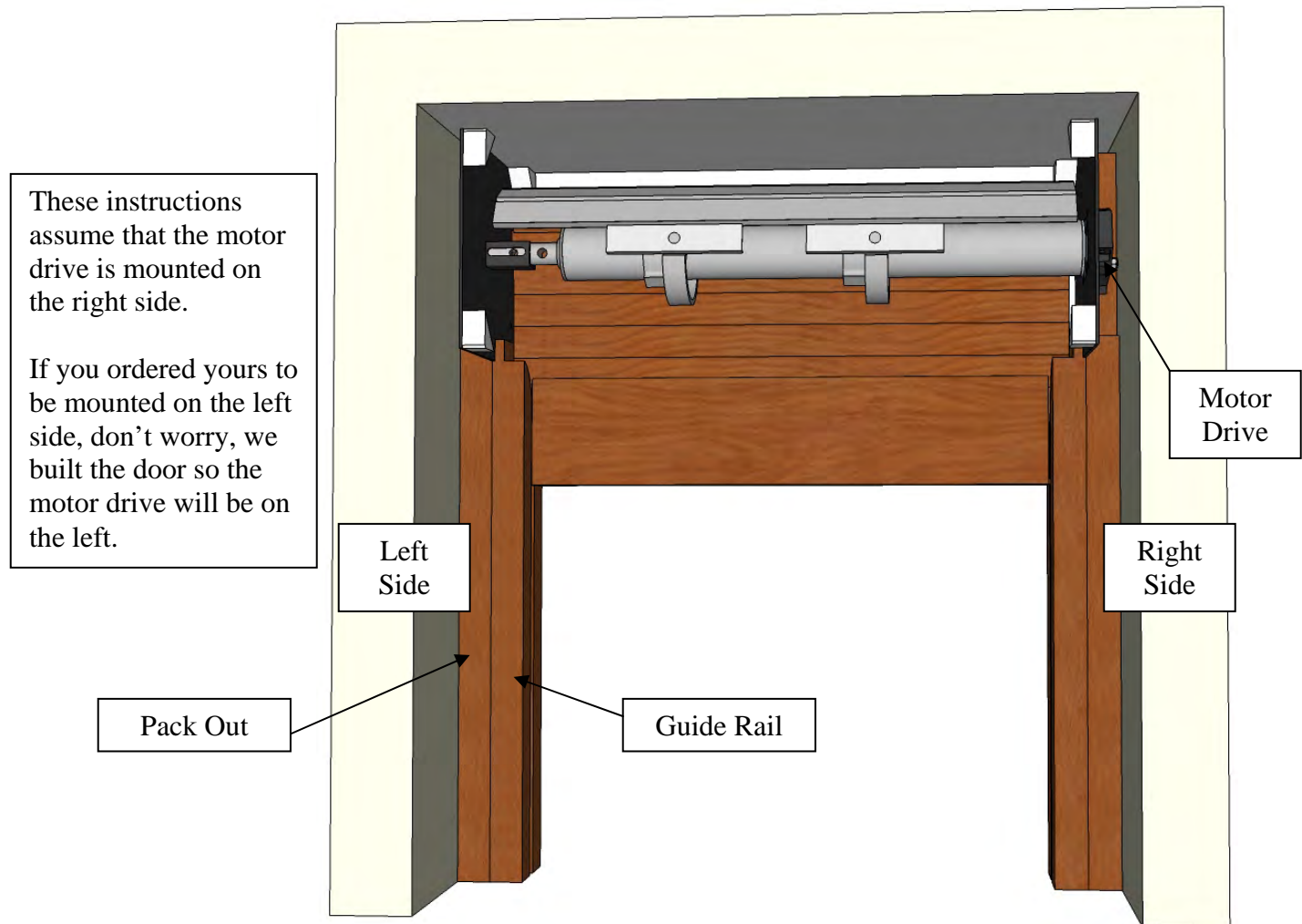

## Step 1

Lay out all the parts on a clean smooth surface.

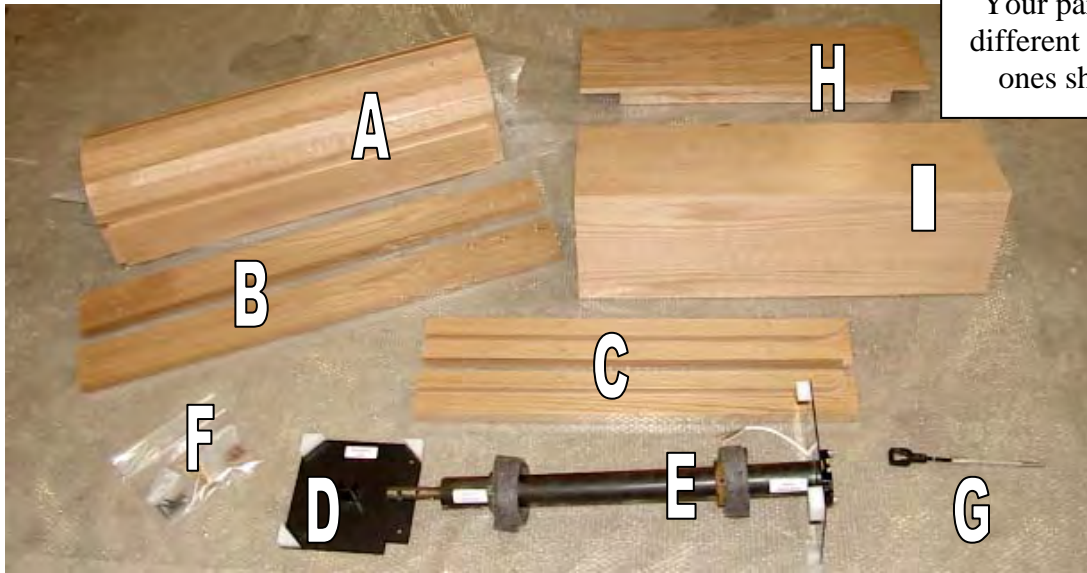

Your parts will be a different size than the ones shown here.

## Items Included In Crate

- A Curtain
- B Pack Outs
- C Guide Rails

- D End Plate
- E Barrel, Motor & End Plate
- F Goody Bag (see below)

- G Manual Override
- H Fascia (if ordered)
- I Hood (if ordered)

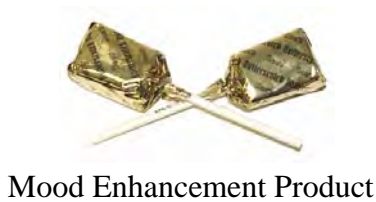

The 2" Shaft Bolt, Capture Nut & Washers (shown at left) are shipped installed as shown to the right. The bolt must be removed prior to installation. Set it somewhere that you can find it because you will need it later.



## Step 2

Your roll-up door has been built based on the measurements in the drawing below.

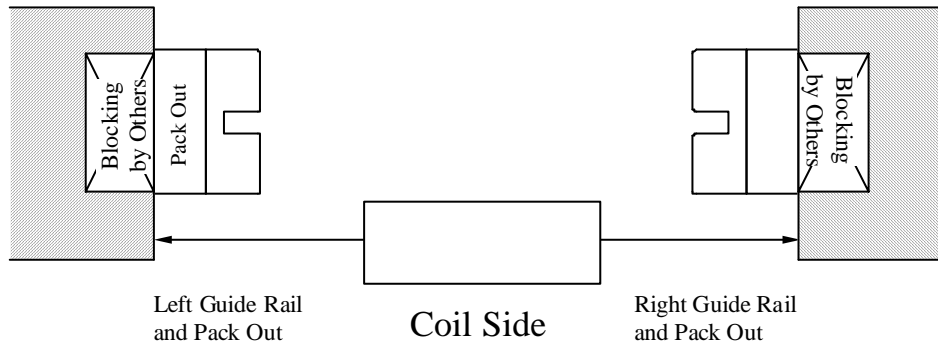

The left and right pack outs have been labeled. Position the left pack out (making sure it is plumb) and secure it using the 3" screws provided. Attach the right pack out making sure it is plumb and level in height with the left pack out. Next, mount the left guide rail on top of the left pack out using the 3" screws provided. The right guide rail can be attached in a similar fashion.



### Viewed From Coil Side

Left



Pack Outs

Right

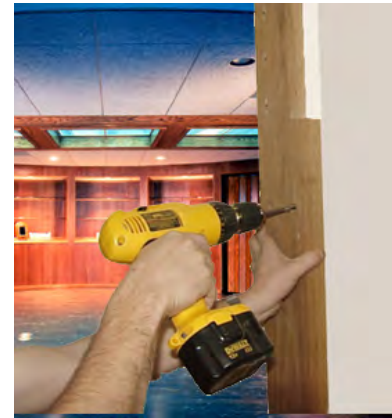

Guide Rails mounted on top of Pack Outs



### Step 3

Standing on the coil side of the door slowly uncoil the curtain while feeding it into the installed guide rails. This curtain weighs \_\_\_\_\_ pounds. If you are by yourself this would be a good time to start making friends. We suggest using at least \_\_\_\_\_ people for this step. **After the door has been completely uncoiled into the guide rails be very careful to not let the top of the door flop over. It can break the top curtain slat.**



**The Roll-Up Guys Working on a small one**



**The Roll-Up Guys & Friends Uncoiling a Big One**

A pencil can be used to hold the metal slats up.



Putting a couple wood blocks on the sill gives you a way to get your fingers out.



## Step 4

Install the loose end plate (the side will be marked with a sticker) onto the pack out using the 1 ¼” bolts provided. The notch on the end plate will fit over the top of the guide rail.



NOTE: You will need to work at the top of the Roll-up door for the *entire width* of the unit. Be sure to allow access to the entire top after installation is complete.

## Step 5

The crank mechanism, barrel and end plate have been assembled at the factory. Your mission is to set the shaft sticking out of the end of the barrel onto the U channel of the installed plate then bolt the other end plate onto the pack out using the 1 ¼” bolt provided..



## Caution:

If you wire the door and operate it without the curtain being attached to the barrel then the limit switches will lose their correct settings and they will need to be reset after the curtain is attached. Please refer to the motor wiring instructions.

This door is supplied with a Somfy motor system. If you have any wiring or technical questions about the motor you can reach the Somfy technical staff by calling (800)227-6639.

### Step 6

Place the short metal curtain slats in the collar notches and attach them using the 3/4" machine screws provided.



### Step 7

The secret to a smooth operating door is tensioning the internal spring hidden inside the barrel. This is accomplished by using two metal rods or large screwdrivers. Insert a rod into a shaft-tensioning hole and pull down 1/4 turn. Holding this position set the second rod into the next tensioning hole. While pulling down with the second rod, release the first and continue "walking" the rods in this manner.

This door was installed at the factory and tested before being packaged. We found that it worked well with \_\_\_\_\_ quarter turns of tension. (same as \_\_\_\_\_ full turns) Secure the shaft in place using the 2" bolt, flat washers and capture nut provided.



## Step 8

A qualified electrician should wire the door motor using the “double throw single pole” paddle switch provided. Run the door up and down a few times to confirm that the limit switches are properly set. If the limit switches need to be reset refer to the motor installation page for instructions.

**Before going any further – double check that the shaft bolt has been secured in place with the flat washer and capture nut.**

**It would also be wise to operate the door 10 to 15 times and then double check that all the bolts and screws are still tight.**

## Step 9

If you ordered a hood it can be installed by sliding it over the end plates. Use the 1 ½” brass plated screws provided to secure the hood to the corner blocks. Two holes have been predrilled on the bottom of the hood for your convenience.

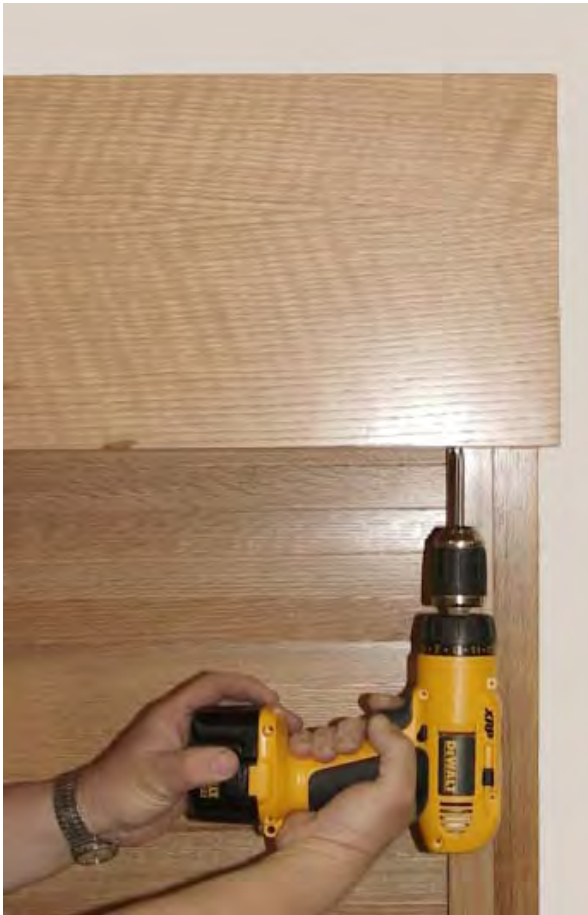

If a fascia was ordered it can be installed using the 1 ½” brass plated screws provided. The Fascia has been predrilled for your convenience.

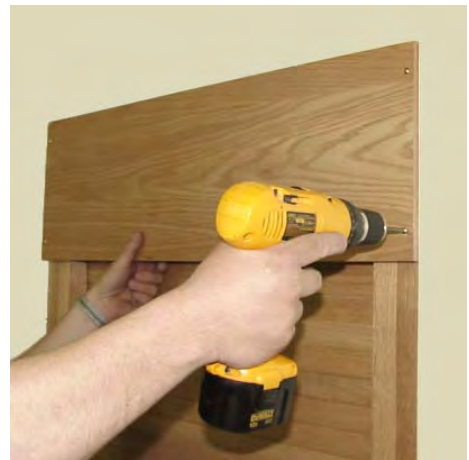

## Step 10

Concealing the guide rail screws with the wood buttons provides the final touch. If you are concerned about them working out, a dab of glue will prevent that from happening.



## Step 11

A manual override has been provided to operate this door in case of power failure. The mechanism and instructions are provided separate from these instructions so that they can be left with the end user. Please take a minute to explain to the customer how to use this feature. If the door was supplied with a hood be sure to show the customer the procedure for removing it to gain access to the motor drive.

## Step 12

At this point you only have one thing left to do. Find those suckers before someone else does.

*Thanks for taking the time and care to install our door in a way that really shows off the quality that we put into each and every one of them.*





# Manual Override Instructions

The motor operating this door comes equipped with manual override capability. In the event of a power failure the door can be operated using the manual override loop which has been supplied with the door.

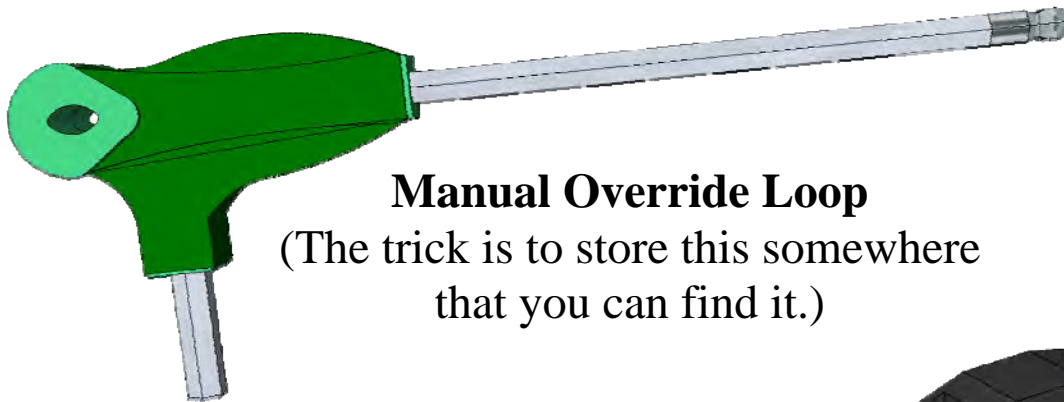

## Manual Override Loop

(The trick is to store this somewhere that you can find it.)

## OVERRIDE PROCEDURE:

Gain access to the motor end of the door. If a hood was installed it will have to be removed.

Insert the manual override loop into the access opening. Turn the loop by hand to raise or lower the door.

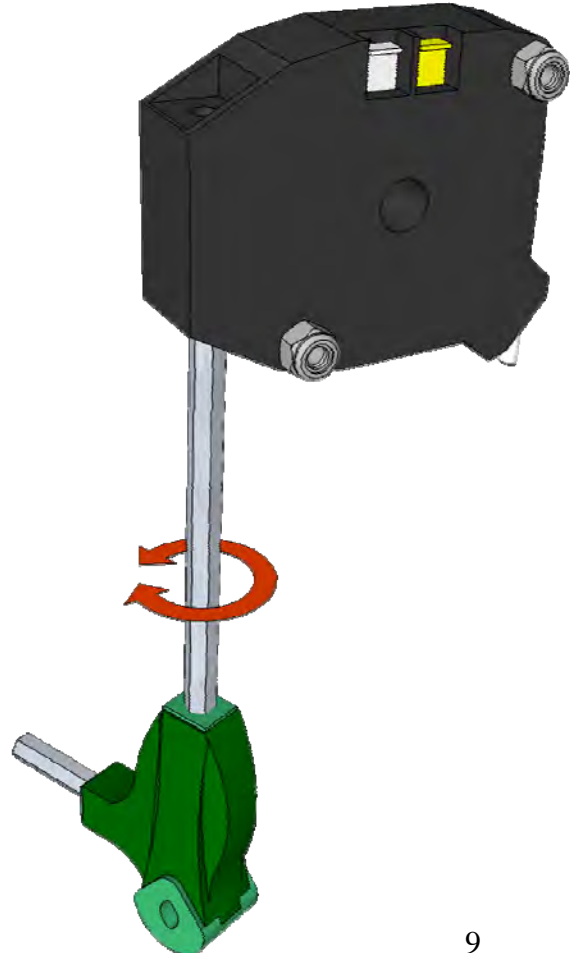

## LT50/60 CMO Motor Installation Instructions

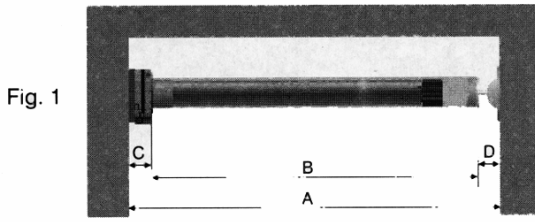

$$B = A - (C + D)$$

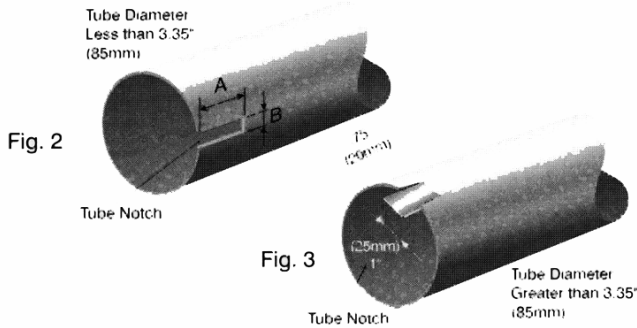

**Notch:** LT50 Length = 25 mm  
LT60 Length = 35 mm

Width = 4 mm  
Width = 8 mm

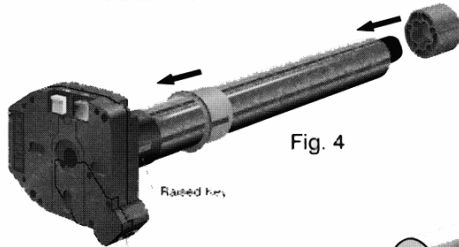

Fig. 4

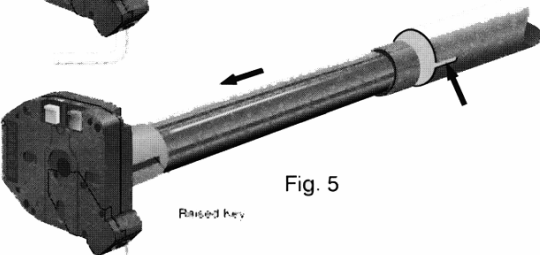

Fig. 5

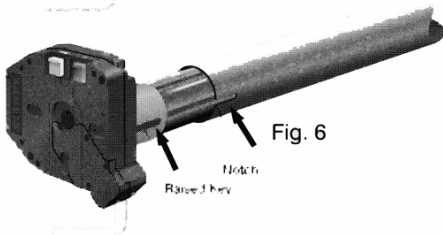

Fig. 6

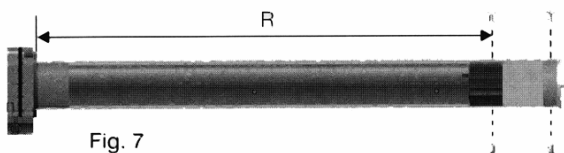

Fig. 7

### 1. TUBE PREPARATION

- Cut the tube to the required length (B), taking into account the width of the installation (A), the motor end clearance (C), and the idler end clearance (D). (See Fig. 1)
- USE FORMULA TO DETERMINE MEASUREMENTS.
- Remove all burrs from the ends of the tube and ensure that the inside of the tube is clean.
- For all round tube sizes up to 3.35" (85 mm) inclusive, notch the tube on the motor end to the dimensions A & B. (See Fig. 2)
- For all tubes over 3.35" (85 mm) form a tongue in the motor end of the tube by making two cuts 1" (25 mm) apart and .75" (20 mm) deep. (See Fig. 3)

### 2. PREPARING THE TUBULAR MOTOR

- Place the crown wheel over the body of the motor. Slide the slot in the motor crown over the raised key on the motor's limit switch unit. (See Fig. 4)  
A crown is not necessary on
  - 2.0" Tube when used with LT50, and
  - 2.5" Tube with LT60.
- Fit the drive wheel on to the output shaft of the motor. There are two types of LT drive wheels: Removable or "SOFT CLIP" type, and fixed or "HARD CLIP" type. The "SOFT CLIP" drives are only available for round tubes in 2.0", 2.5", and 2.75" diameters. The drive wheel can be removed by physically pulling it off the motor shaft. For the ease of identification all "SOFT CLIP" drives are **BROWN**. The "HARD CLIP" drives can only be removed from the shaft by pressing the two clips inward at the same time. The motor must be out of the tube in order to have access to the clips. These drives are **BLACK**.

### 3. FITTING THE MOTOR INTO THE TUBE

For round tubes: Measure the drilling length R according to the motor type listed in the table below. Fit the motor into the tube ensuring that the notch at the end of the tube slides over the raised key on the crown wheel. (See Fig. 5, 6) Secure the drive wheel to the tube using four 7/32 steel pop rivets or four 1/4 DIA. screws. Fit the end plug into the other side of the tube and secure it with three steel pop rivets. Use only fasteners with steel grades SAE 5 or higher. Metric fasteners must be grade 8.8 or higher. (See Fig. 7)

### LT50 CMO

MOTOR TYPE	R in. / mm
525A2 CMO	22.80/579
530R2 CMO	22.80/579
535A2 CMO	25.55/649
540R2 CMO	25.55/649
550R2 CMO	25.55/649

### LT60 CMO

MOTOR TYPE	R in. / mm
660R2 CMO	24.8/630
680R2 CMO	26.2/665
6100R2 CMO	26.2/665

#### 4. LIMIT SWITCH SETTING

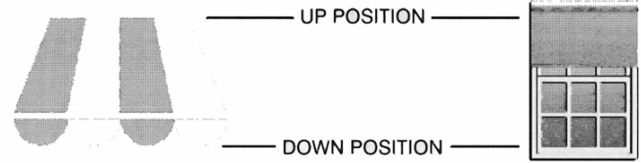

Sequence:

- 1 Remove the protective cap covering the limit setting buttons on motor head, and replace when finished.
- 2 Depress fully both limit switch push buttons. They will automatically lock in the down position. Operate the T.C. switch and check that the system operates correctly. Identify the UP limit switch push button (refer to figure used for step 1). Press the T.C. switch in the UP direction until the required position is reached. Set the switch to the center "OFF" position.
- 3 Unlock the UP limit switch push button by depressing and releasing it.
- 4 Repeat the above operation to set the lower limit. Check with the switch that the motor stops at the up & down positions just set.
- 5 Always remember to affix the protective cap over the limit switch buttons.

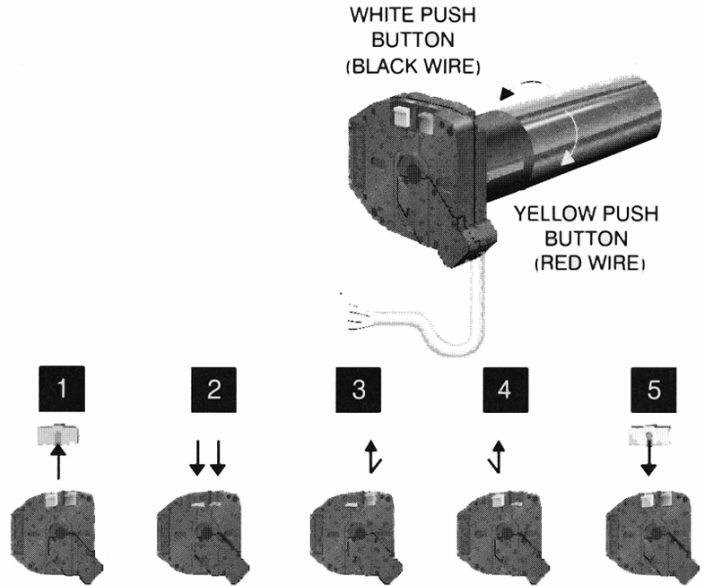

**NOTE:** Tubular motors are not continuously rated. They have a built-in thermal overload device which limits their operation to approximately 5 minutes.

#### 5. WIRING/INSTALLATION RECOMMENDATIONS

- A. All wiring must conform to NEC (National Electrical Code) and local codes
- B. Do not wire two or more motors to one SPDT (single pole double throw switch-NO PARALLEL WIRING).
- C. Do not use light switches.
- D. Do not wire two or more switches to one motor, without using SOMFY's multi switch command. Cat. No. 6300427.

**NOTE: SOMFY motors conform to IP44 requirements and as such must be protected against direct weather elements such as rain, sleet,...etc.**

**SOMFY reserves the right to void the motor warranty if the wiring recommendations are not followed.**

#### 6. TROUBLESHOOTING GUIDE

##### SYSTEM DOES NOT RESPOND

- Is the power supply switched on - check any fuses in the system?
- Is control switch wired correctly? Refer to instructions.
- Are limit switches set properly? Review limit switch settings.
- The thermal protective device may have shut the motor off. Wait for the motor to cool down.
- Check the wiring between the motor & the switch.
- Disconnect the switch & test the motor with a tester cable.

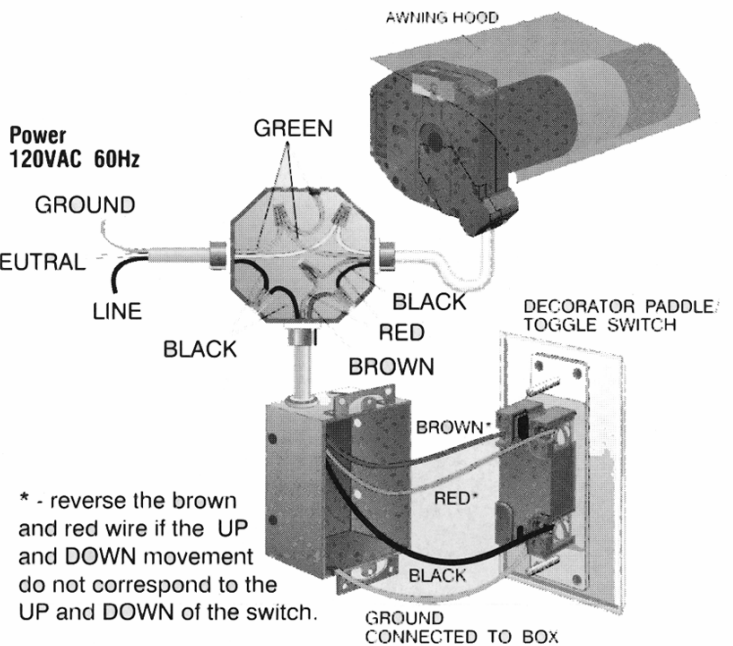

##### THE SYSTEM IS NOT STOPPING

- Is the limit switch crown wheel being driven by the tube (has tube profile been properly notched)?
- Is motor drive wheel securely fastened to the tube?

**NOTE: if the motor is tested outside the tube, the crown wheel has to be manually turned in order to stop the rotation of the output shaft.**



# Check List

Customer Name: \_\_\_\_\_

Order Number: \_\_\_\_\_

Ship Date: \_\_\_\_\_

- \_\_\_\_\_ Curtain
- \_\_\_\_\_ Pack Outs
- \_\_\_\_\_ Guide Rails
- \_\_\_\_\_ End Plate
- \_\_\_\_\_ Barrel, Motor, End Plate Assembly
- \_\_\_\_\_ Manual Override
- \_\_\_\_\_ Fascia
- \_\_\_\_\_ Hood
  
- \_\_\_\_\_ Hardware Bag
  - \_\_\_\_\_ Guide Rail Screws
  - \_\_\_\_\_ Collar Bolts
  - \_\_\_\_\_ Suckers
  - \_\_\_\_\_ Switch & Plate
  - \_\_\_\_\_ Pack Out Screws
  - \_\_\_\_\_ 1 1/4" End Plate Bolts
  - \_\_\_\_\_ Buttons
  - \_\_\_\_\_ Hood & Fascia Screws
  - \_\_\_\_\_ Thank You Note
  
- \_\_\_\_\_ Shaft Bolt, Capture Nut & Washers
- \_\_\_\_\_ Shop Drawings
- \_\_\_\_\_ Motor wiring instructions
  
- \_\_\_\_\_ Installation Instructions
  - \_\_\_\_\_ Distance between back of guide rails
  - \_\_\_\_\_ Curtain weight
  - \_\_\_\_\_ Number of people to install curtain
  - \_\_\_\_\_ Number of quarter turns
  - \_\_\_\_\_ Page 1 note about left mounted motor
  
- \_\_\_\_\_ End Plate Stickers have been attached
- \_\_\_\_\_ Guide Rail Stickers have been attached
- \_\_\_\_\_ Barrel Stickers have been attached
- \_\_\_\_\_ Pack Out Stickers have been attached