

View From Coil Side
Manual Operation

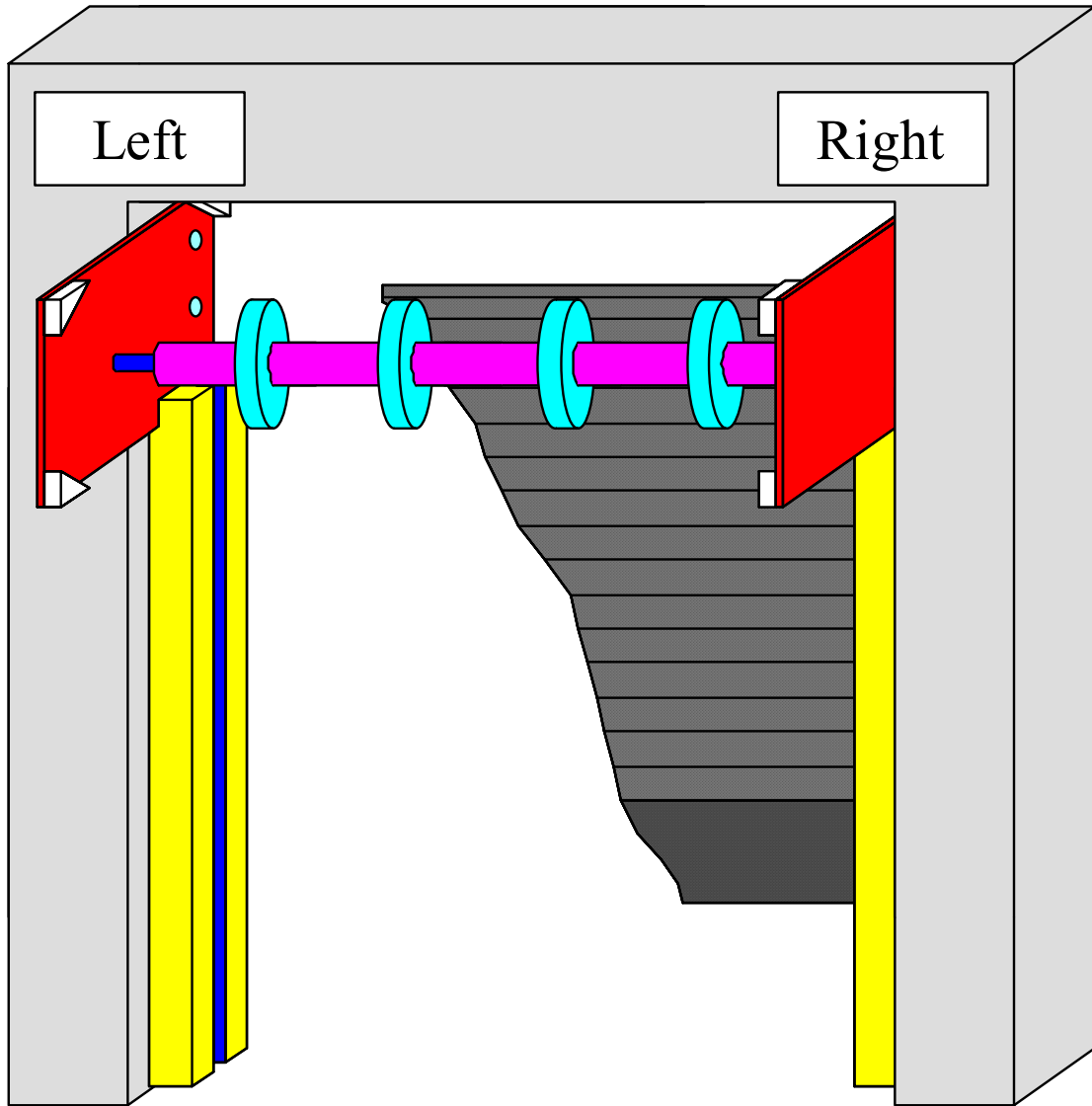

Inside Mount
Under Lintel
(Shown Without Hood or Fascia)

View From Coil Side
Motor or Crank Operation

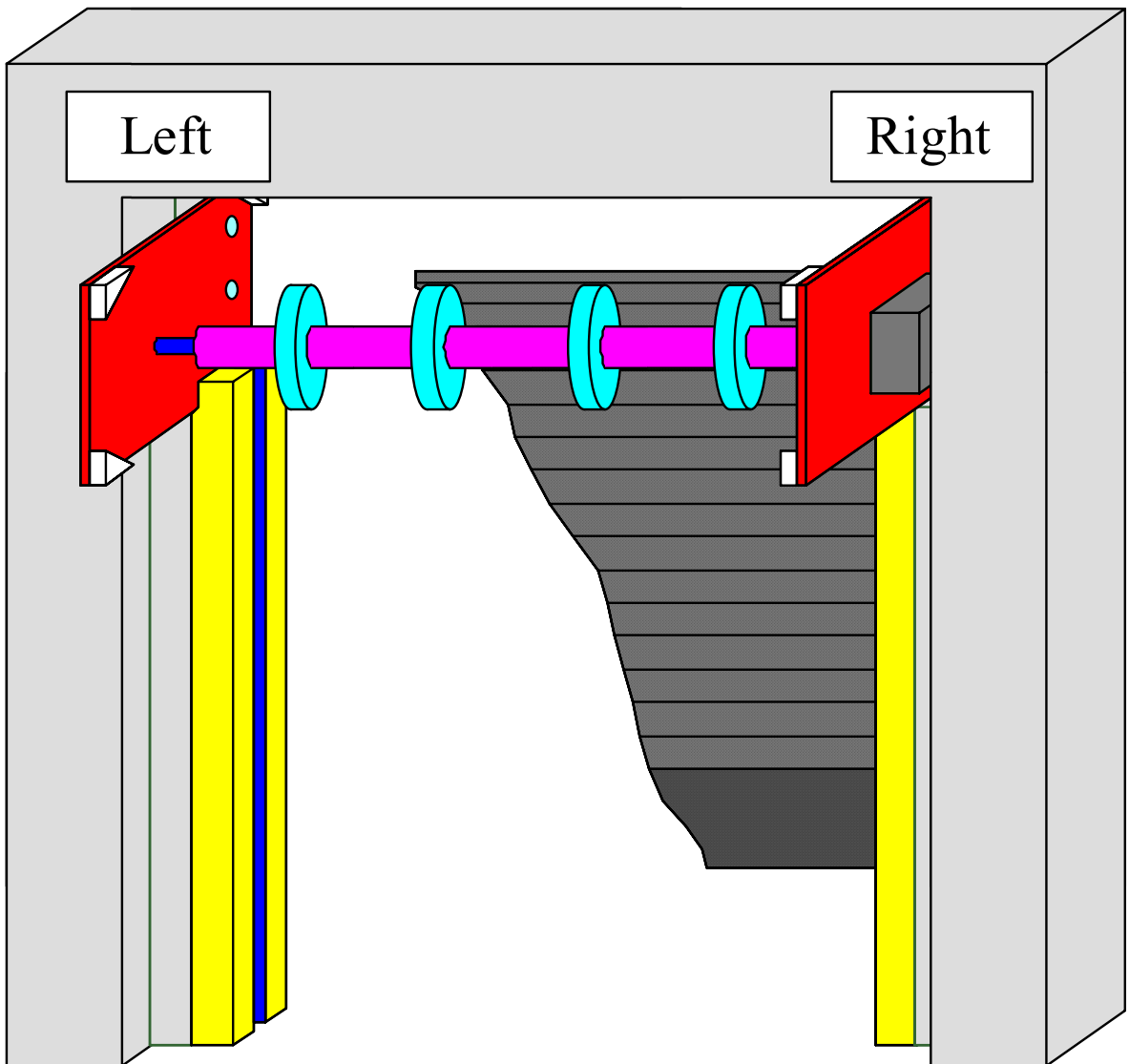

Inside Mount
Under Lintel With Pack Outs
(Shown Without Hood or Fascia)

End Plate Detail With Fascia & Hood

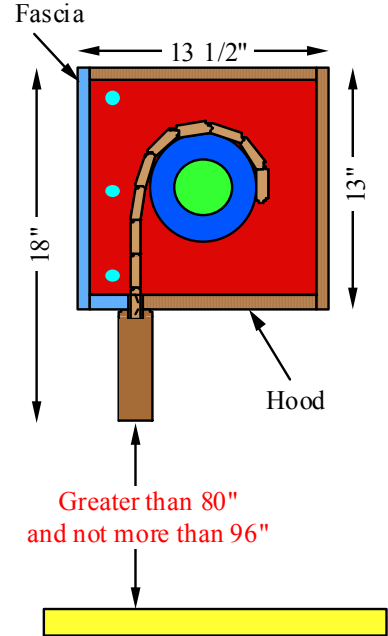
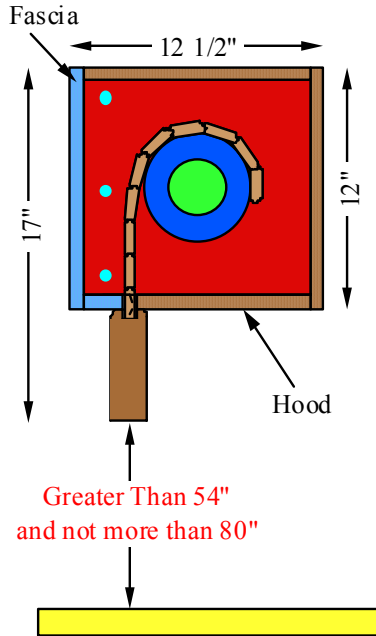
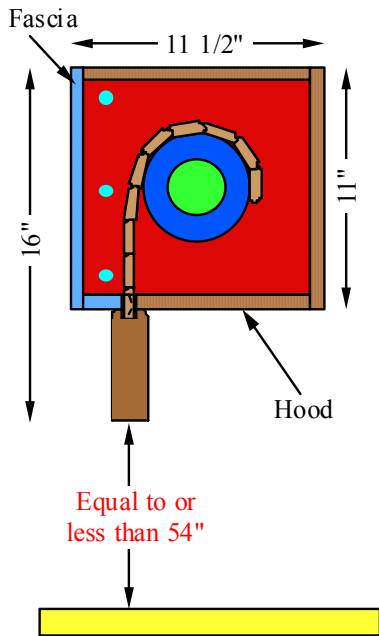

End Plate Detail Without Fascia & Hood

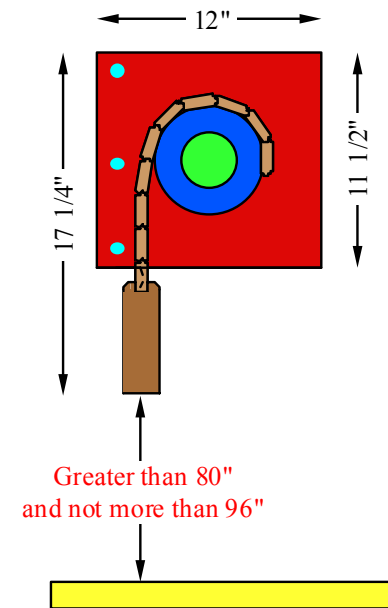
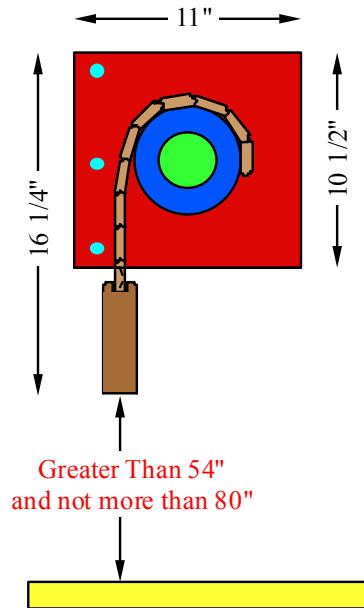
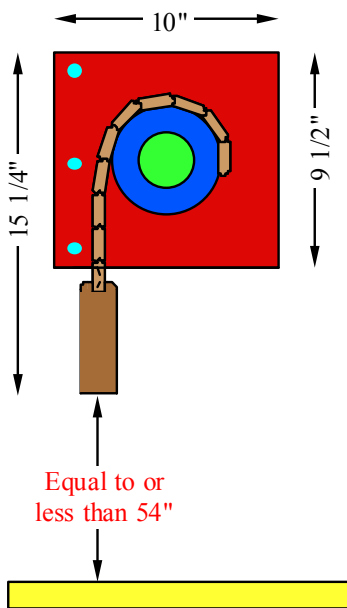

Inside Mount Under Lintel

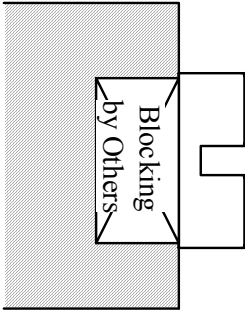

Manual
Operation

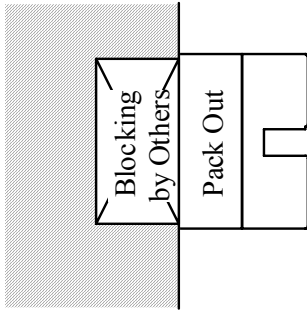
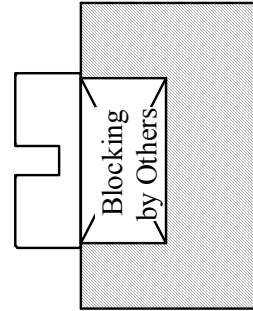

Motor
Operation

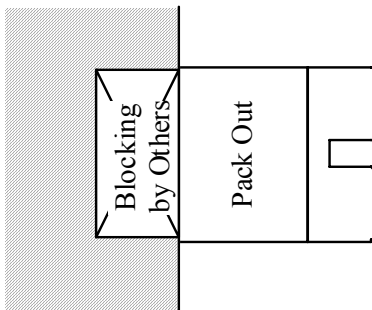
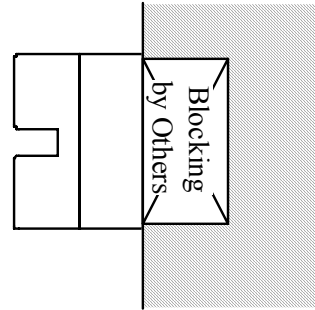

Crank
Operation

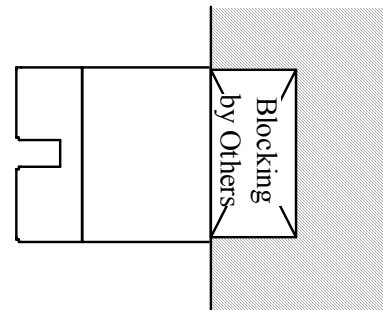

Left

Coil Side

Right

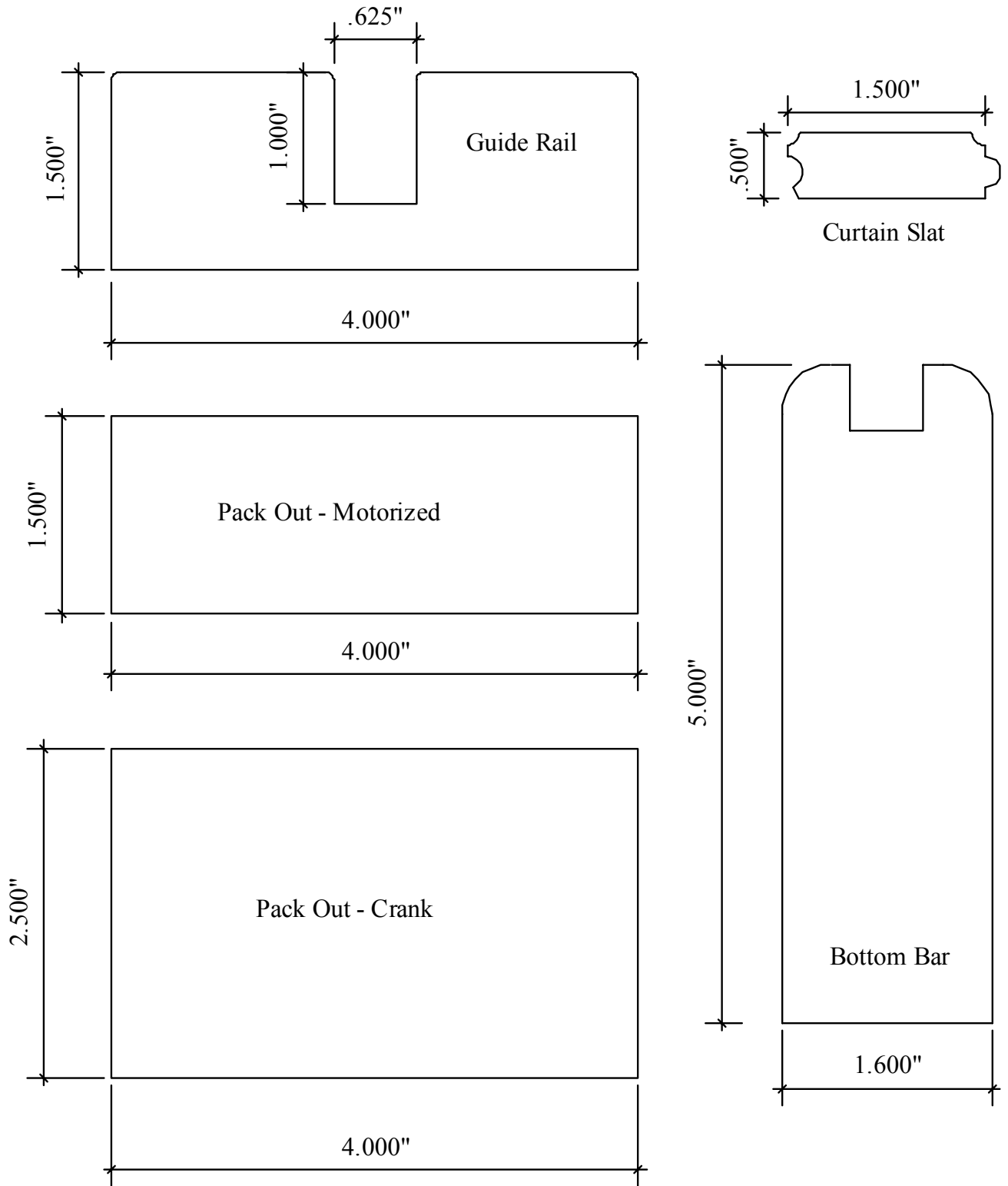

Inside Mount Under Lintel