

I-Beam Track

Curvable at job site
to a 12" minimum radius

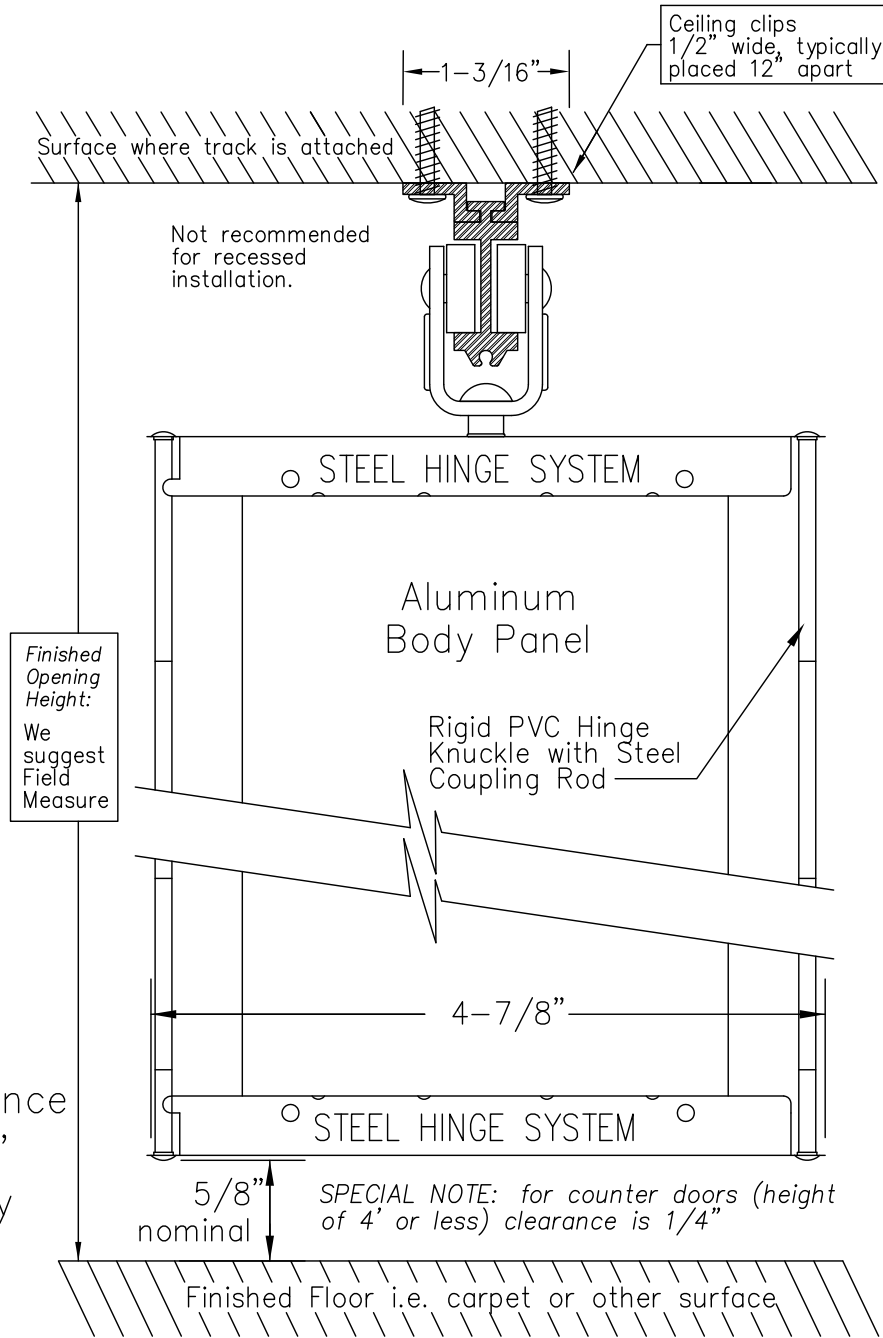

For Floor Clearance
other than $\frac{5}{8}$ "
please specify

Woodfold Manufacturing, Inc.
PO Box 346 Forest Grove OR 97116
<http://www.woodfold.com>

CAD IBM-740

○ I-BEAM — MODEL 740