

Surface Track

*Pan head screw supplied
by manufacturer or equivalent*

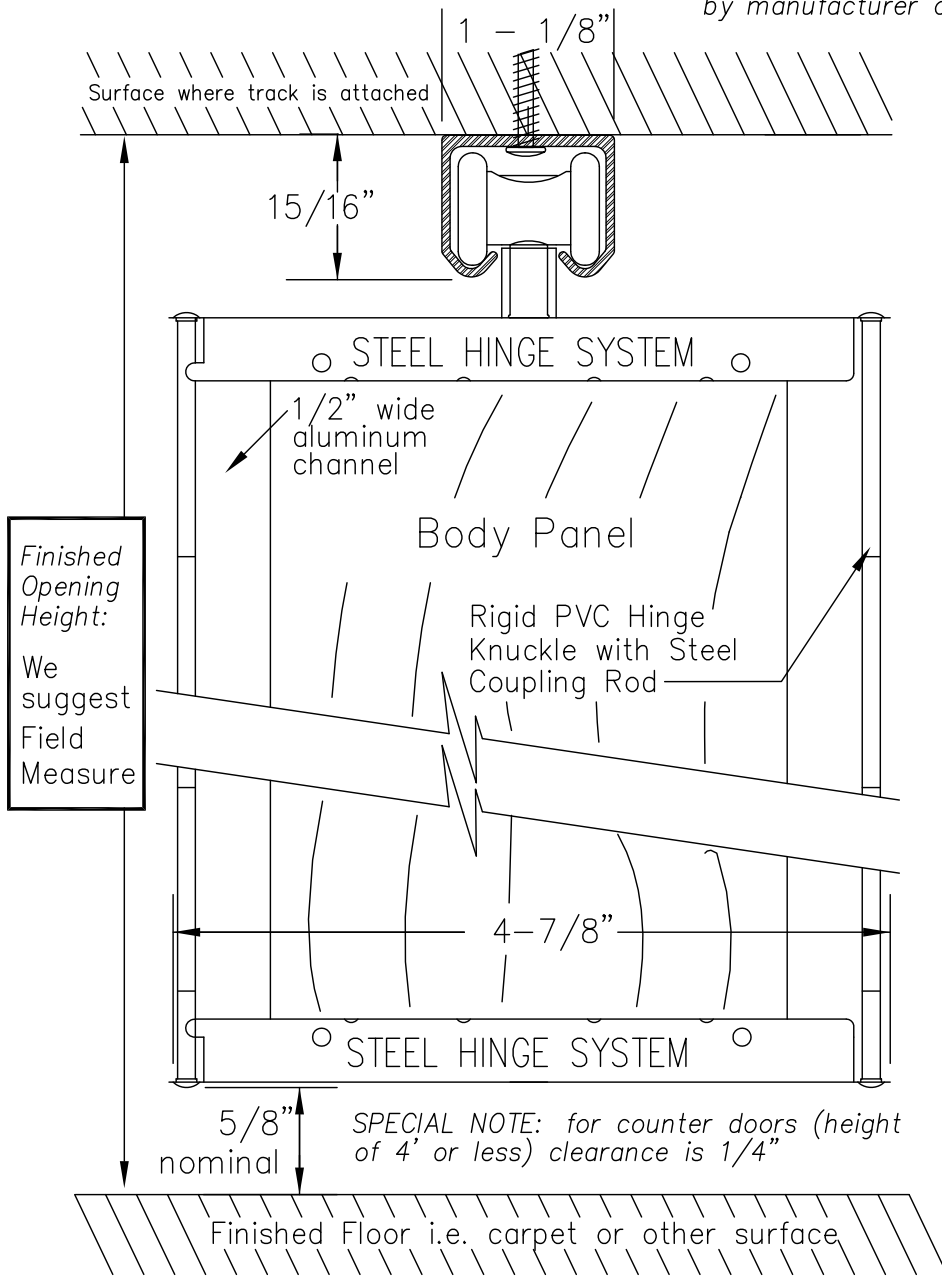

Woodfold Manufacturing, Inc.
PO Box 346 Forest Grove OR 97116
<http://www.woodfold.com>

CAD SRTK-540

○ SURFACE TRACK — MODEL 540