

Sliding Jamb Option

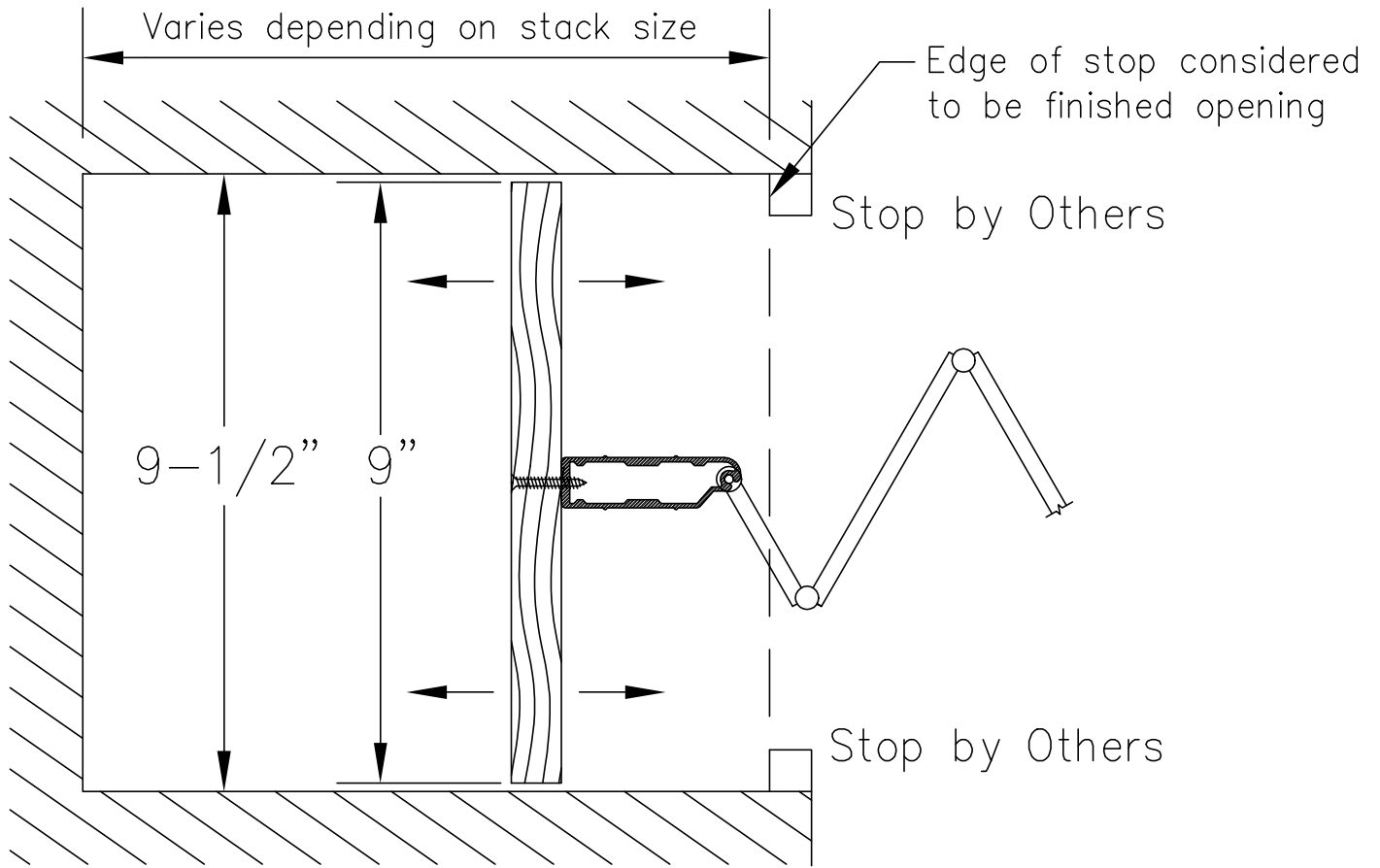

CAD SJO-540